

## ***1. Introduction to Sound***

The sound section is composed of circuitry which produces 4 types of sound, namely sounds 1,2,3 and 4, as specified below. The sound section can also synthesize and reproduce external patterns.

- Sound1: Produces quadrangular waves with sweep and envelope functions.
- Sound2: Produces quadrangular waves with an envelope.
- Sound3: Outputs voluntary wave patterns from Wave RAM.
- Sound4: Produces white noise with an envelope.

Each sound has two modes: ON and OFF.

### **1.1 ON MODE**

According to the data set in the Mode register of each sound, the various sounds are produced. The data in the Mode register can be set at all times while producing sound.

### **1.2 INITIAL FLAG**

When setting initial value of the envelope and restarting the length counter, set the initial flag at "1" and initialize the data.

### **1.3 MUTE**

When the output level at sound 3 is set to mute (bits 5 and 6 of NR32=0), no sound will be produced regardless of the setting of the ON flag.

### **1.4 STOP**

Under the following situations, the ON flag is reset and sound output stops:

- when the sound output is stopped by the length counter.
- when overflow occurs in the addition mode while the sweep is operating in Sound 1.

### **1.5 OFF MODE**

During OFF mode, the operation of the frequency counter and the D/A converter stops, producing an interruption in sound output.

## 1.6 SOUND 3

When the sound OFF flag (bit 7 of NR30) is reset to “0”, cancellation of the OFF mode must be performed by setting the sound OFF flag to a “1”. This is performed by Sound 3.

## 1.7 ALL SOUND OFF MODE

When all the sound ON/OFF flags (bit 7 of NR52) are set to “0”, the mode registers for Sounds 1, 2, 3 and 4 are reset, and all sound output stops. To cancel this mode, set bit 7 of NR52 to “1”, then set all the sound ON/OFF flags to “1”.

(Note: The setting of each sound’s mode register must be done after the All Sound Off mode is cancelled. While this flag is set, sound mode registers cannot be set).

## Chapter 2 Sound Control Register

### 2.1 SOUND MODE 1 REGISTER

Sound 1 is a circuit that produces a quadrangular wave pattern with sweep and envelope functions. It must be set at registers NR 10, NR 11, NR 12, NR 13, and NR 14.

NAME ADDRESS  
**NR10 FF10**

key:  is not used  
 is read/write  
 is write only

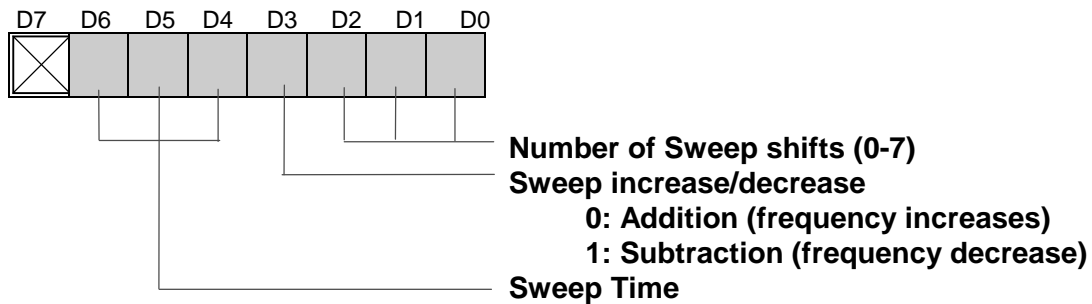

#### 2.1.1 NUMBER OF SWEEP SHIFTS

The change of frequency (NR 13, NR14) at each shift is calculated by the following formula:

$$X(t) + X(t - 1) \pm (t - 1) / 2^n$$

Where; X (0) = Initial Data

X (t-1) = Previous Frequency

n = 0~7

When calculating the above formula, if the value of a bit exceeds bit 11, the output of the sound stops, and the Sound 1 ON flag (at bit 0 of NR52) is reset. During the subtraction, when the value becomes less than 0, the value shown prior to the calculation will be the current value, thus making X (t) = X(t-1). However, when n=0, there will be no shift and the frequency remains unchanged.

#### 2.1.2 SWEEP TIME ts

At each ts period, frequency changes.

000	: Sweep OFF	
001	: ts = 1/f128	(7.8 ms)
010	: ts = 2/f128	(15.6 ms)
011	: ts = 3/f128	(23.4 ms)
100	: ts = 4/f128	(31.3 ms)

---

101	:	$ts = 5/f_{128}$	(39.1 ms)	
110	:	$ts = 6/f_{128}$	(46.9 ms)	
111	:	$ts = 7/f_{128}$	(54.7 ms)	$f_{128} = 128\text{Hz}$

Figure 2-2-1 Example, Sweep Wave Pattern

When NR10=79H and initial frequency data = 400H sweep wave pattern will be:

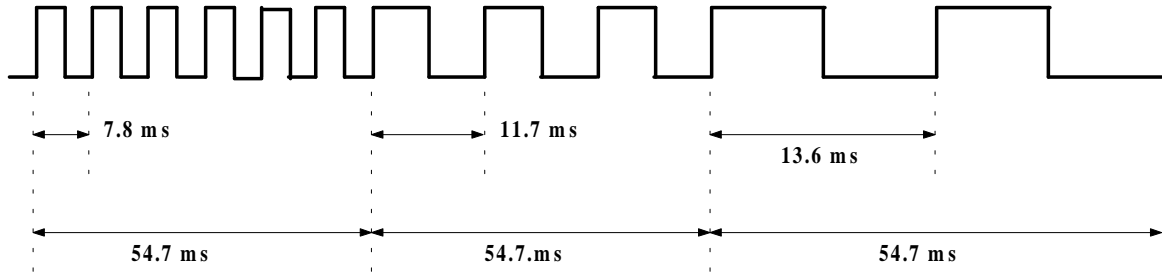

- Note: When the sweep function is not used, set the increase/decrease flag at "1" (subtract mode).

NAME ADDRESS

**NR11 FF11**

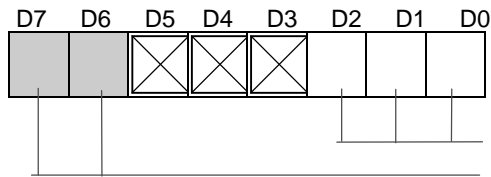

**Sound Length Data (0 ~ 63)  
Wave Pattern Duty**

Sound Length =  $(64-t1) * (1/256)$  sec  
Wave Duty

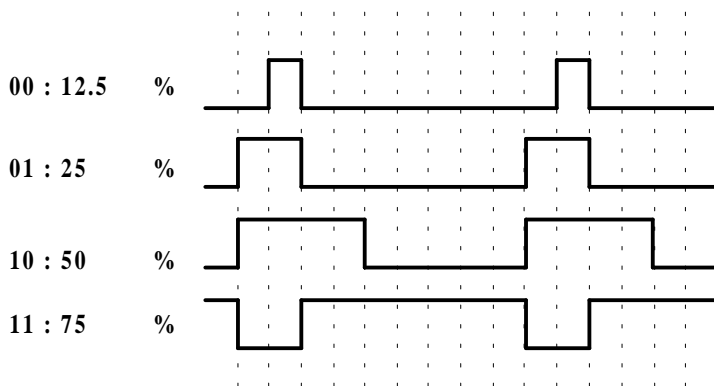

NAME ADDRESS

**NR12 FF12**

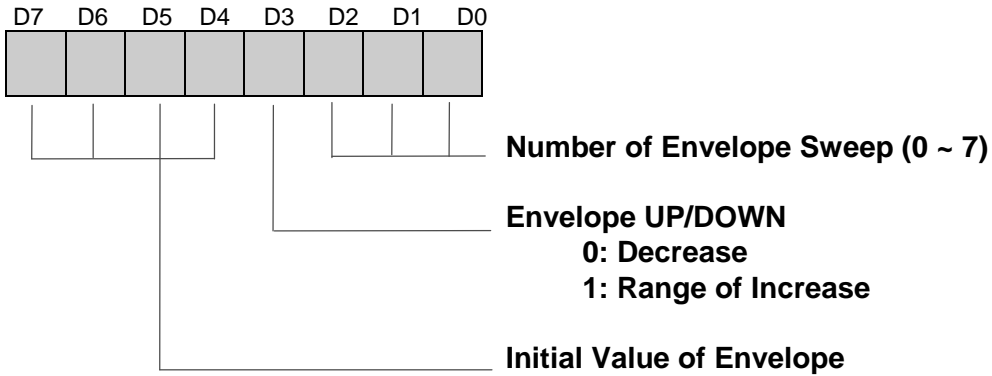

**2.1.2.1 NUMBER OF ENVELOPE STEPS**

set the range of increase or the length of a one-step decrease. The length of one-step =  $n * (1/64)$  sec. At  $n = 0$ , the envelope function stops.

**2.1.2.2 INITIAL VALUE OF ENVELOPE (0000 - 1111)**

Using the 4-bit D/A circuit, 16 levels of steps can be specified. It's maximum level is 1111 and becomes mute at 0000.

Figure 2-2-2 Example, Initial Envelope Value

When NR12 = 94H,  
Amp gain is:

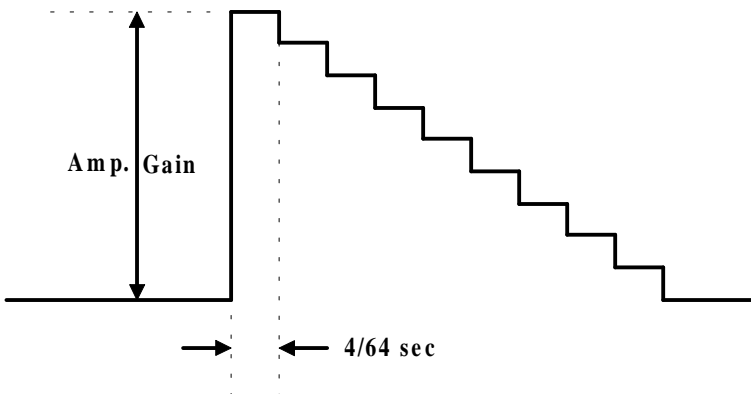

NAME ADDRESS

**NR13 FF13**

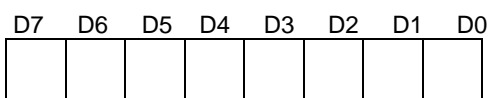

**Frequency Data (Low) (all bits)**



NAME ADDRESS  
**NR14 FF14**

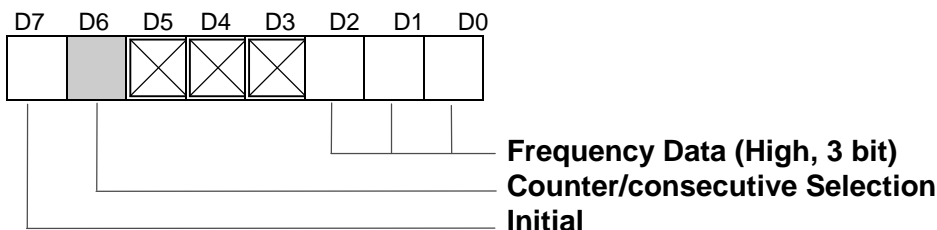

2.1.2.3 COUNTER/CONSECUTIVE SELECTION

When “0”, regardless of the length of data on the NR11 register, sound can be produced consecutively. When “1”, sound is generated during the time period set by the length data contained in register NR11. After the sound is output, the Sound 1 ON flag, at bit 0 of register NR52 is reset.

2.1.2.4 INITIAL

When this bit is set at “1”, Sound 1 starts again. Suppose the 11 bit frequency data set at NR13 and NR14 is X. Then the output frequency (f) can be calculated by the following formula.

$$f = 4194304 / (4 * 2^3 * (2048 - X))Hz$$

Therefore, the minimum frequency will be 64Hz and the maximum frequency will be 131.1Khz.

2.1.3 CAUTIONS WHEN USING SOUND 1

- When the sweep function is not used at Sound 1, set the sweep time at 0 (sweep OFF) and either set the sweep increase/decrease flag at 1 or the sweep shift number at 0. (Set NR10 at 04H ~ 07H or 00H.)
- If the sweep increase/decrease flag of NR10 is set at 0 (addition mode), the sweep shift number may be anything other than 0, and the sweep OFF mode is set (e.g., NR10=01H), there are cases in which no sound is produced.
- When changing the content of the envelope register (NR12) while the sound is operating (i.e., when the ON flag is at 1), set the value at the envelope register before setting the initial flag.

2.2 SOUND 2 MODE REGISTER



Sound 2 is a circuit that produces a quadrangular wave pattern with an envelope function. It can be set at registers NR21, NR22, NR23, and NR24.

NAME ADDRESS

**NR21 FF16**

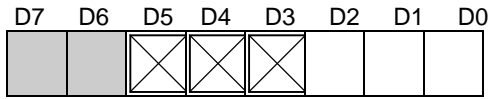

Sound Length Data (0 ~ 63)  
Wave Pattern Duty

NAME ADDRESS

**NR22 FF17**

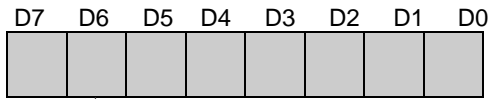

Number of Envelope Sweeps (0 ~ 7)  
Envelope UP/DOWN  
0: Decrease  
1: Range of Increase  
Initial Value of Envelope

NAME ADDRESS

**NR23 FF18**

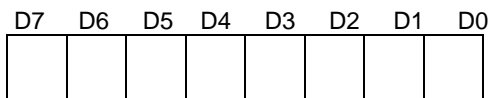

Frequency Data (Low) (all bits)

NAME ADDRESS

**NR24 FF19**

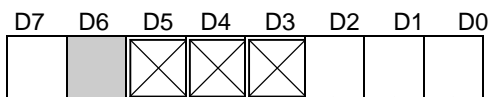

Frequency Data (High, 3 bit)  
Counter/consecutive Selection  
Initial

### 2.2.1 COUNTER/CONSECUTIVE SELECTION

When “0”, regardless of the length data on the NR21 register, sound is produced consecutively. When “1”, sound is generated for the time period set by the length data contained in register NR21. After the sound is output, The Sound 2 ON Flag (bit 1) of register NR52 is reset.

### 2.2.2 INITIAL

When this bit is set at “1”, Sound 2 starts again.

### 2.2.3 CAUTIONS WHEN USING SOUND 2

When changing the content of the envelope register (NR22) while the sound is operating (i.e., when the ON flag is at 1), set the value at the envelope register before setting the initial flag.

## 2.3 SOUND 3 MODE REGISTER

Sound 3 is a circuit which produces a voluntary wave pattern. It automatically reads the wave pattern (one cycle) written on addresses FF30H ~ FF3FH of a Wave Pattern RAM. This wave pattern can be output while changing the length, frequency, and sound level using registers NR30, NR31, NR32, NR33, and NR34. Assignment of sound length, frequency function are similar to the Sound 1 circuit.

NAME ADDRESS  
**NR30 FF1A**

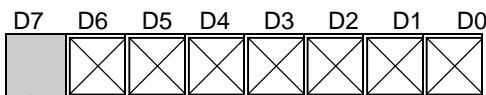

**Sound OFF**  
**0: Sound 3 Output Stop**  
**1: Sound 3 Output OK**

NAME ADDRESS  
**NR31 FF1B**

R/W Select the Sound Length

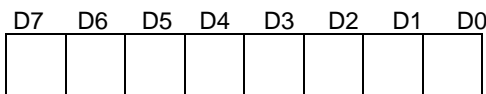

**Sound Length Data (t1) (all bits)**

Sound Length = (256-t1) \* (1/256) sec



NAME ADDRESS  
**NR32 FF1C**

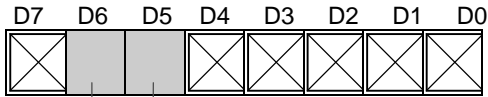

**Select Output Level**

Output level:

00 : Mute

01 : Produce the wave pattern RAM data as it is (4-bit length).

10 : Produce the wave pattern RAM data (4-bit length) at the one-bit right shift (1/2) form.

11 : Produce the wave pattern RAM data (4-bit length) at the 2-bit right shift (1/4) form.

NAME ADDRESS  
**NR33 FF1D**

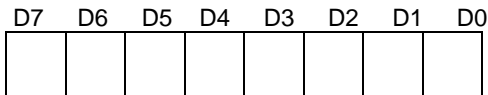

**Frequency (Low) (all bits)**

NAME ADDRESS  
**NR34 FF1E**

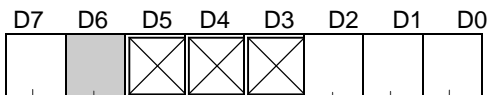

**Frequency Data (High, 3 bit)**  
**Counter/consecutive Selection**  
**Initial Flag**

### 2.3.1 COUNTER/CONSECUTIVE SELECTION

When this bit is set to “0”, sound is produced consecutively, regardless of the length data on the NR31 register. When set to “1”, sound is generated for the length of time set by the length data contained in register NR31. After the sound is output, the ON flag of Sound 3, bit 2 of register NR52, is reset.

### 2.3.2 INITIAL FLAG

When the sound OFF flag (NR30, bit 7) is at “1”, and a “1” is assigned to bit 7 of NR34, Sound 3 starts again.

### 2.3.3 PROGRAMMING CAUTIONS

When changing frequency while outputting Sound 3, the Initial flag must not be set. This may cause data in the Wave RAM to be destroyed.

The initial flag may be set during the output of Sound 1, 2, and 4.

#### WAVE RAM FORMAT

ADDRESS	D7	D6	D5	D4	D3	D2	D1	D0
FF30		Step 0				Step 1		
FF31		Step 2				Step 3		
FF32		Step 4				Step 5		

....all the way down to:

FF3F		Step 30				Step 31		
------	--	---------	--	--	--	---------	--	--

[EXAMPLE] CHOPPING WAVE

FF30H - 01H, 23H, 45H, 67H  
 89H, ABH, CDH, EFH  
 EDH, CBH, A9H, 87H  
 65H, 43H, 21H, 00H

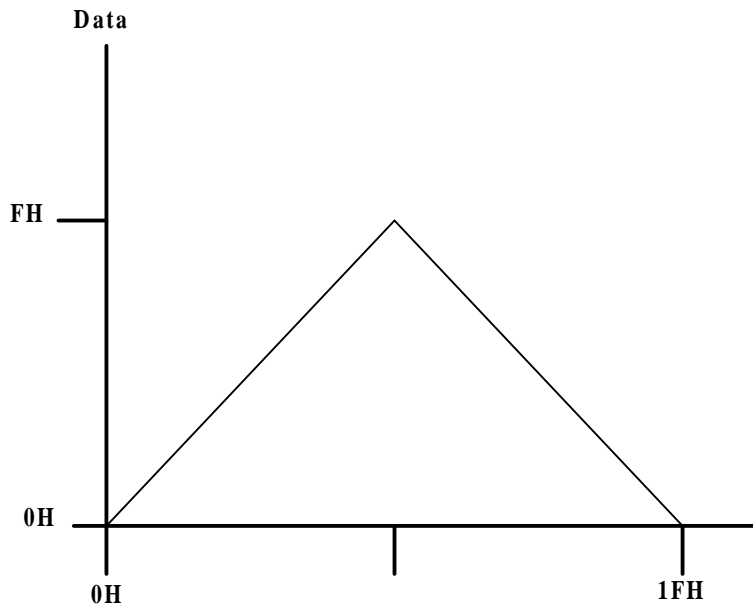

### 2.4 SOUND 4 MODE REGISTER

Sound 4 is a circuit that produces white noise. It's output data is produced by switching the step of the polynomial counter that produces frequencies and random numbers. This is performed by changing the frequency ratio and envelope data using registers NR41, NR42, and NR44.

NAME ADDRESS

**NR41 FF20**

R/W Select the Sound Length

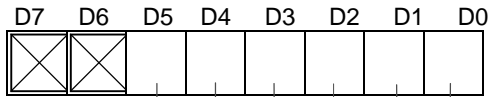

Sound Length Data t1 (0 ~ 63)

NAME ADDRESS

**NR42 FF21**

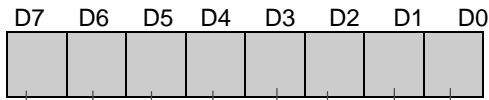

Number of Envelope Steps (0 ~ 7)

Envelope Up/Down  
 0: Decrease  
 1: Range of Increase

Initial Value of Envelope

NAME ADDRESS

**NR43 FF22**

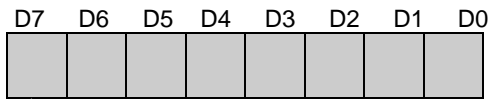

Selection of Frequency Ratio  
 Selection of Polynomial Counter's Step  
 Selection of the Shift Clock Frequency  
 for the Polynomial Counter

### 2.4.1 SELECTION OF FREQUENCY RATIO

The polynomial counter's shift clock is comprised of a 14-step pre-scaler. Select the input clock of the pre-scaler, as follows:

- 000:  $f * 1/2^3 * 2$
- 001:  $f * 1/2^3 * 1$
- 010:  $f * 1/2^3 * 1/2$
- 011:  $f * 1/2^3 * 1/3$
- 100:  $f * 1/2^3 * 1/4$
- 101:  $f * 1/2^3 * 1/5$
- 110:  $f * 1/2^3 * 1/6$
- 111:  $f * 1/2^3 * 1/7$

### 2.4.2 SELECTION OF POLYNOMIAL COUNTER STEP

- 0: 15 steps
- 1: 7 steps

### 2.4.3 SELECTIONS OF POLYNOMIAL COUNTER CLOCK

- 0000: Ratio of Frequencies \* 1/2
- 0001: Ratio of Frequencies \* 1/2<sup>2</sup>
- 0010: Ratio of Frequencies \* 1/2<sup>3</sup>
- 0011: Ratio of Frequencies \* 1/2<sup>4</sup>
- .....
- 1101: Ratio of Frequencies \* 1/2<sup>14</sup>
- 1110: Not Used
- 1111: Not Used

NAME ADDRESS (F.H Note: The Name and Address for this register are written verbatim, but most likely it should read, "Name NR44 : Address FF23")  
**NR30 FF1A**

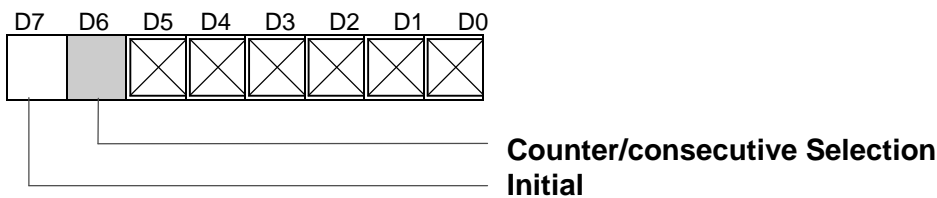

### 2.4.4 COUNTER/CONSECUTIVE SELECTION

Regardless of the length on the NR41 register, sound is produced consecutively while this bit is "0". When bit 6 is set to "1", sound is generated for the time period set by the



---

length data contained in register NR41. After the sound is output, the ON flag of Sound 4 (bit 3 of register NR52) is reset.

**2.4.5 INITIAL**

When bit 7 is "1", Sound 4 starts again.

**2.4.6 PROGRAMMING CAUTIONS**

When changing the content of the envelope register (NR22) while the sound is operating (ON flag at "1"), set the value at the envelope register before setting the Initial flag.

**2.5 SOUND CONTROL REGISTER**

NAME ADDRESS  
**NR50 FF24**

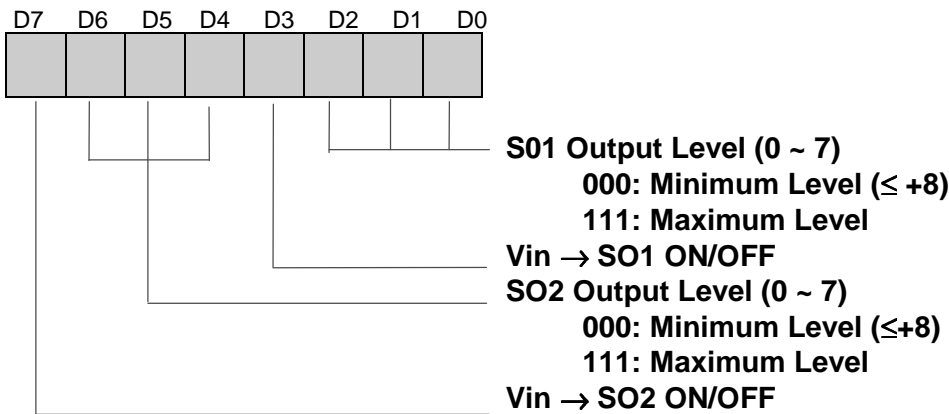

Vin → SO1 (Vin → SO2)

The voice input for a Vin terminal is produced by synthesizing the combined sound from Sounds 1 through 4.

- 0: No Output
- 1: Output OK

NAME ADDRESS  
**NR51 FF25**

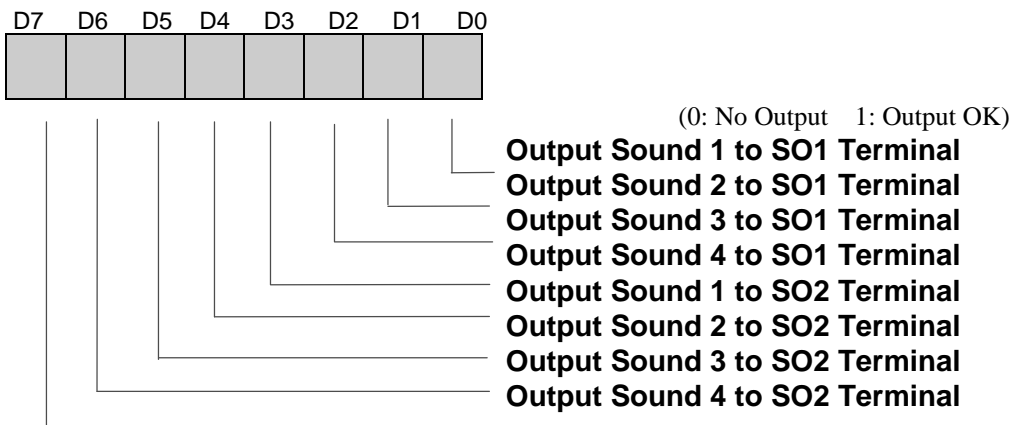

NAME ADDRESS  
**NR52 FF26**

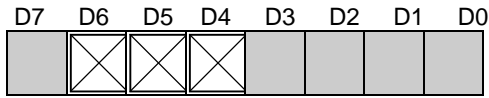

**Sound 1 ON Flag**  
**Sound 2 ON Flag**  
**Sound 3 ON Flag**  
**Sound 4 ON Flag**  
 Each sound is set during its output. It is reset at the counter mode after the time set by the length data elapses.  
**All sound ON/OFF**  
     **0: Stop all sound circuits**  
     **1: Operate all sound circuits**

\*\*\*\*\*

Credits:  
 Game Boy Sound Document (version 1.2) was brought to you by NoComply, F.H.  
 Document Reproduced by F.H.

\*\*\*\*\*